

C | 4i

- x | ä ä
- x É 9 ÿ ß
- x ... a' y [% Q < k » % Q <
- x ¶ • y' y v' k 9' k ? è' k "
- '
- x / 6
- x 9 + 2 <
- x v Å ' "



C | 5 é

+ (< 9 ^ ^ ^ 9 < , © ç = / 6 É 9 Ü ~ D } k ç ÿ µ 9 8 < G I k Å Ä Ý ä ä
 œ fo ž 4 © ç D } © • % Å ç k x Ô Å ç C ö œ Å ç ^ • ò — ‹ ož Ý ä | ä k - Ø Û Ó — ‹ k ' ñ
 • ½ k â Ý ^ a U ä 4 D } U ' Å k w • x 4 D } . x ož ¶ • y ' k , ... a' o • v' o • 9 '
 o • ? è' C " " k ¾ © ' š 4 4 . D } — ž I ô ož

1 Y æ =

Î Þ Ô 8	Î ´ Ô 8 ÿ (1)	Î Þ Ô W ÿ	£ Ü Î Þ ' (2)] ´ (3)	´) d	1 Y
					220Vac	

l u g h))) • š 9 8 y < G I ! "))) \$ Û • š 9 8 y < G l ož
 g h W • ÿ µ 9 8 y < G I k ç < G I ¶ ÿ µ 9 8 g i Ô - @ f t ' ì ¼ ç hož
 g h y i Ú ^ y < G I k ç ú g i Ô - @ f t • " hož

ÿ µ È ä 8		-		
¥ v				
ÿ µ v				< G I k ç ú

Î 4î x

? d	£ 3 š	À 1 š	£ Ü š	Ô I
~ ... v g / Zh				< G I k -ê "g Õ Ñ o h k / V Q / V Q k 4 Õ ž • # f Y z ! Õ Ñ @ f ~ ... v ¼ ž
ä œ f				ž ú
È ´ f â 1				g h

Î Þ4î x

? d	£ 3 š	À 1 š	£ Ü š	Ô I
ÿ ß 9 ð †				ž ú
È ÿ ß 9 ¼ f				ž ú ož " P f ~ 3 . ` k ! Ú ^ k ÿ ß w Ä f , G Ì y f , † ož
o ï 9				ž ú
ž À² ... ä				ž ú
ž ú² ... ä				
• Ñ o ž •				< G I k ž ú
Á € •	ÿ ß ž [ž • ' ž • y µ
	ú 3 ž •			ž ú y ž ú
" † © f		q		Ó " q Á Ý ›

I u ñ Ä Å @ f ® " † q Õ Ñ ñ O y Á ° > k Õ ð h ç " Û ož

P á é

? d	£ 3 š	À 1 š	£ Ü š	Ô I
ä				ž ú k q ê "
u ® — { ž ž •				< G I k ê " - k ž ú 3 / 2 . * (1 ,
. x ž •				< G I k ž ú k Ó " - k ! Õ Ñ @ f . x ¼ ž

P á é

¿ d	£ 3 š	À 1 š	£ Ü š	Ô I
• Ó “				
À ‘ Ó “			q	v Á ‘ ñ + • Á ‘ Ó “ ~ t y
¥ “ †				~ t y
> * 6 * 2 ~ = ~ . D œ 2 ~ = ~ .				m 5 ö > * ^ ^ ^ ^
Ô M				

I u ñ Ā Ā @ f ® “ † q Õ Ñ ñ O y Á ° › k Ô ð h ç “ Û o ž

μ Ô Ā × Ô

μ ù ç	× Ô
+ 3 / × Ô	Ô I
EMS × Ô	Ô I

μ Ô Â × Ô

EMS × Ô	Ô I

Iu g h › á +3/ ö Ö k x 9 › • ° À © Ī %² B ã k - È ` ° À Ä € - Ö g +3/ , ¼ G • ož

` › • Ž

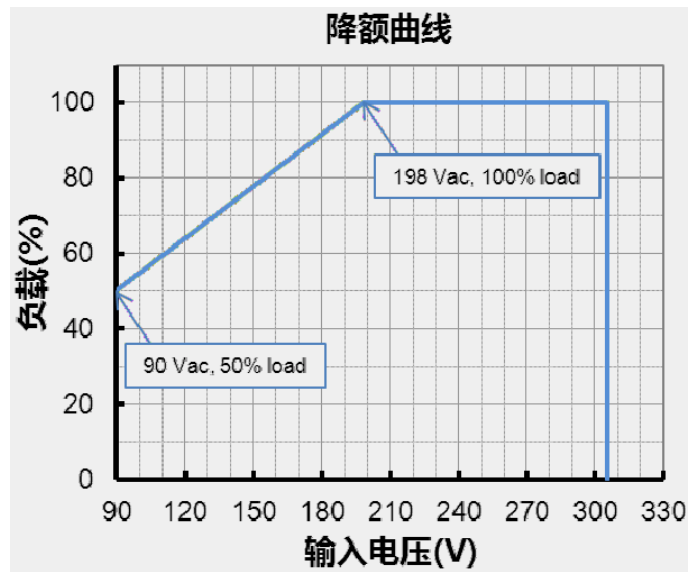

- w * Ô t • Ž

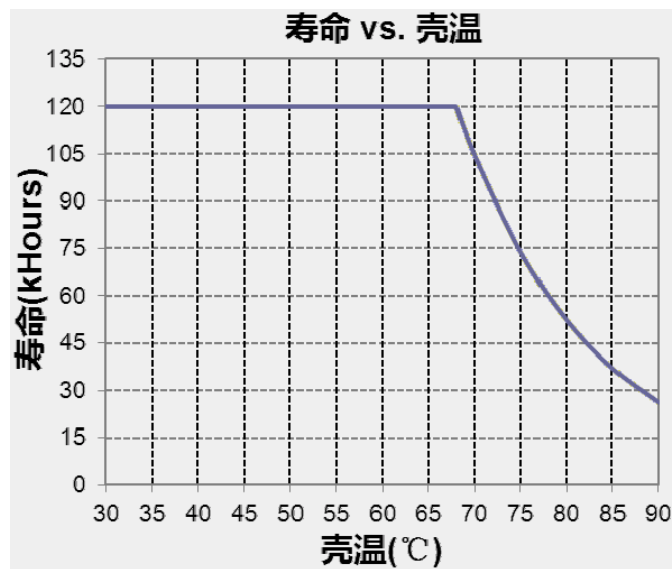

• Ž

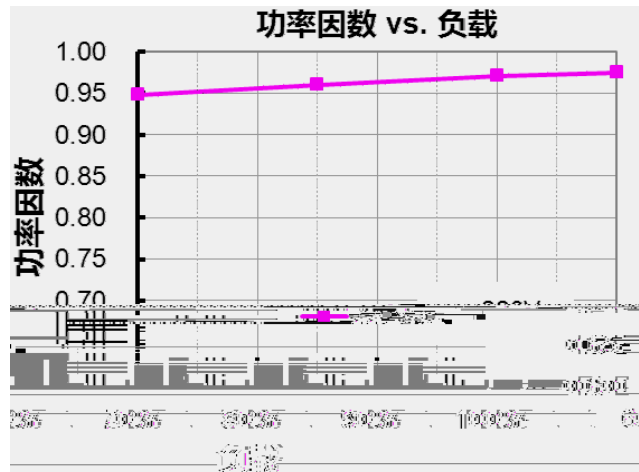

5 f G á • Ž

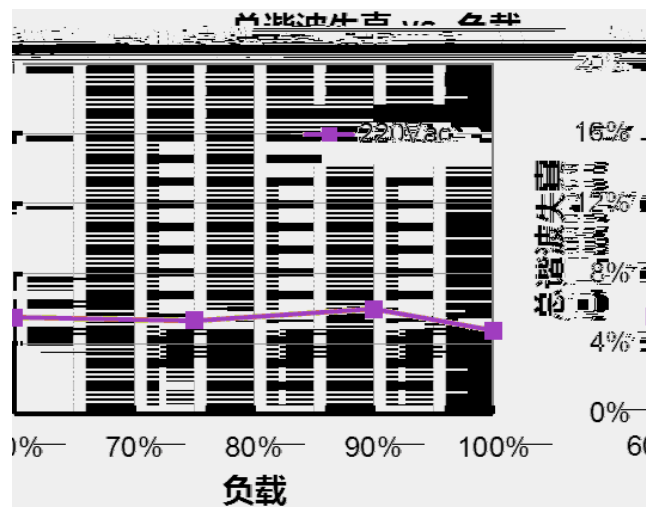

• Ő x

• Ő	• Ő
v'	È Ő % "ož { ž L" ž k È Őož
9'	ý ß 9 k' ò " • 8 Äož
? è'	È Ő % "ož ? è ž k D } — C oož ? è L" ž k U È Őož
" "	È Ő % "ož " †" ž k U È Ő 3 oož

2 Ä ø

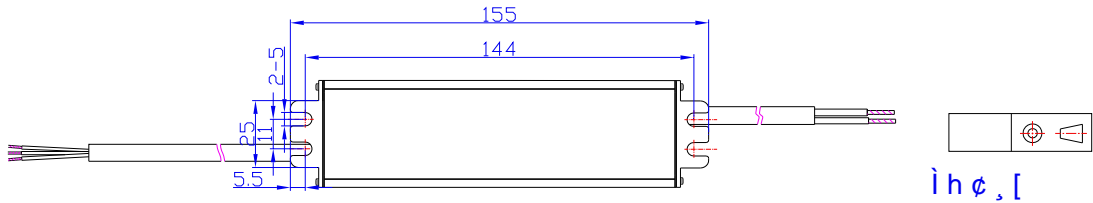
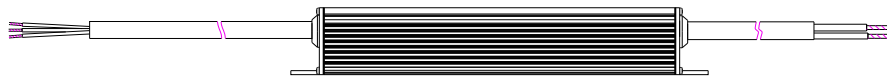
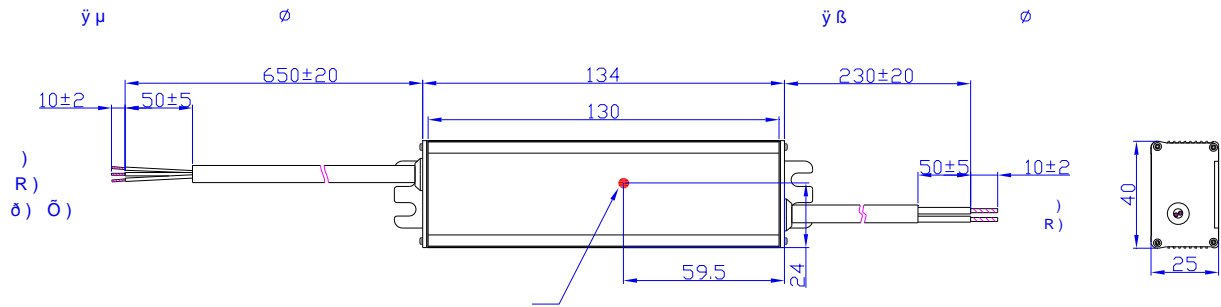

T_ 8U.9 L-

é[D}...` , (8U.9 6X

+ ; C ç Â • “œ 6 X g + ; h

ož

' [b ç

' X • N	• -	' X 5 é		
		• ù	Q	è
		G g		
		° Z ç n Õ h	g h • š 98 y < G lož	g h))) • š 98 y < G I! "))) \$ Û • š 9 8 y < G lož
		Ñ ã £		¾ •