

- 93.5%
-
-
-
-
- 6 kV, 10 kV
-
- IP67 UL
- SELV
- Class I, Division 2
- 5

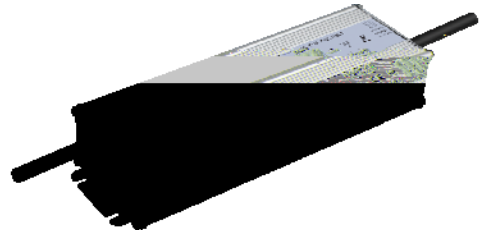

EUP-240SxxxST

240W

90-305Vac

	(1)		(2)			(3)			(4)
							120Vac	220Vac	
500-1050mA	700-1050mA	700 mA	90~305 Vac/ 127~300 Vdc	114~343Vdc	240W	93.5%	0.99	0.96	EUP-240S105ST
850-1500mA	1050-1500mA	1050 mA	90~305 Vac/ 127~300 Vdc	80~229Vdc	240W	93.5%	0.99	0.96	EUP-240S150ST
1000-2100mA	1400-2100mA	1400 mA	90~305 Vac/ 127~300 Vdc	57~171Vdc	240W	93.5%	0.99	0.96	EUP-240S210ST
2000-4200mA	2800-4200mA	4200 mA	90~305 Vac/ 127~300 Vdc	29 ~ 86Vdc	240W	92.5%	0.99	0.96	EUP-240S420ST ⁽⁵⁾
3400-6700mA	4600-6700mA	6700 mA	90~305 Vac/ 127~300 Vdc	18 ~ 52Vdc	240W	92.0%	0.99	0.96	EUP-240S670ST ⁽⁵⁾

1 240W

2 UL, FCC 100-277Vac 127-300Vdc; 100-240Vac 127-250Vdc KS

3 100% 220Vac " "

4 KS EUP-240S105ST

5 SELV

	-	-	0.5%	100%
	-	-	1.5%	
	-	-	1.0 s	120Vac, 70%-100%
	-	-	0.5 s	220Vac, 70%-100%
	-	0.03%/°C	-	= 0°C ~ Tc

25°C

@ 120Vac				
EUP-240S105ST				
Io= 700 mA	88.5%	90.5%	-	
Io=1050 mA	87.5%	89.5%	-	
EUP-240S150ST				
Io=1050 mA	88.5%	90.5%	-	
Io=1500 mA	87.5%	89.5%	-	
EUP-240S210ST				100% 25°
Io=1400 mA	88.5%	90.5%	-	
Io=2100 mA	87.0%	89.0%	-	2%
EUP-240S420ST				
Io=2800 mA	87.5%	89.5%	-	
Io=4200 mA	85.5%	87.5%	-	
EUP-240S670ST				
Io=4600 mA	87.0%	89.0%	-	
Io=6700 mA	85.0%	87.0%	-	
@ 220Vac				
EUP-240S105ST				
Io= 700 mA	91.5%	93.5%	-	
Io=1050 mA	90.0%	92.0%	-	
EUP-240S150ST				
Io=1050 mA	91.5%	93.5%	-	
Io=1500 mA	90.0%	92.0%	-	
EUP-240S210ST				100% 25°
Io=1400 mA	91.5%	93.5%	-	
Io=2100 mA	90.0%	92.0%	-	2%
EUP-240S420ST				
Io=2800 mA	90.5%	92.5%	-	
Io=4200 mA	88.5%	90.5%	-	
EUP-240S670ST				
Io=4600 mA	90.0%	92.0%	-	
Io=6700 mA	88.0%	90.0%	-	

@277Vac				
EUP-240S105ST				
Io= 700 mA	92.0%	94.0%	-	
Io=1050 mA	90.5%	92.5%	-	
EUP-240S150ST				
Io=1050 mA	92.0%	94.0%	-	
Io=1500 mA	90.5%	92.5%	-	
EUP-240S210ST				100% 25° 2%
Io=1400 mA	92.0%	94.0%	-	
Io=2100 mA	90.5%	92.5%	-	
EUP-240S420ST				
Io=2800 mA	91.0%	93.0%	-	
Io=4200 mA	89.0%	91.0%	-	
EUP-240S670ST				
Io=4600 mA	90.5%	92.5%	-	
Io=6700 mA	88.5%	90.5%	-	
	-	241,000 Hours	-	220Vac, 25, 80% (MIL-HDBK-217F)
	-	84,000 Hours	-	220Vac 80% 70
	-40°C	-	+88°C	
	-40°C	-	+75°C	5
	-40°C	-	+85°C	: 5%RH to 100%RH
(L x W x H)	8.35 x 2.66 x 1.56			9.17 x 2.66 x 1.56
(L x W x H)	212 x 67.5 x 39.7			233 x 67.5 x 39.7
	-	1200 g	-	

25°C

UL/CUL	UL8750,CAN/CSA-C22.2 No. 250.13
CE	EN 61347-1, EN61347-2-13
KS	KS C 7655
EMI	
EN 55015 ⁽¹⁾	Conducted emission Test &Radiated emission Test
EN 61000-3-2	Harmonic current emissions
EN 61000-3-3	Voltage fluctuations & flicker

EMI	
FCC Part 15 ⁽¹⁾	ANSI C63.4 Class B
	This device complies with Part 15 of the FCC Rules. Operation is subject to the following two conditions: [1] this device may not cause harmful interference, and [2] this device must accept any interference received, including interference that may cause undesired Operation.
EMS	
EN 61000-4-2	Electrostatic Discharge (ESD): 8 kV air discharge, 4 kV contact discharge
EN 61000-4-3	Radio-Frequency Electromagnetic Field Susceptibility Test-RS
EN 61000-4-4	Electrical Fast Transient / Burst-EFT
EN 61000-4-5	Surge Immunity Test: AC Power Line: line to line 6 kV, line to earth 10 kV ⁽²⁾
EN 61000-4-6	Conducted Radio Frequency Disturbances Test-CS
EN 61000-4-8	Power Frequency Magnetic Field Test
EN 61000-4-11	Voltage Dips
EN 61547	Electromagnetic Immunity Requirements Applies To Lighting Equipment

: 1 EMI () EMI
 2 , / ()
 (IEC 60598-1-10.2)

降额曲线

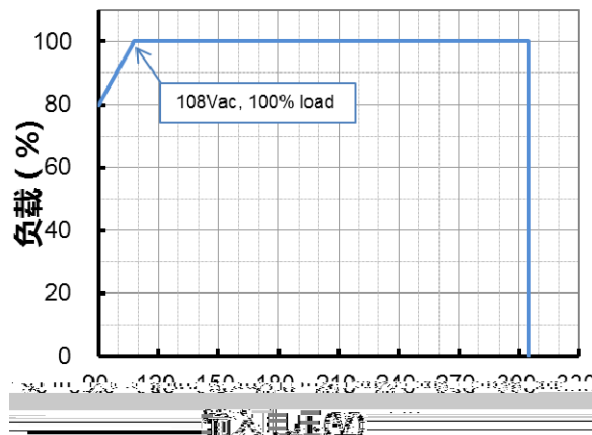

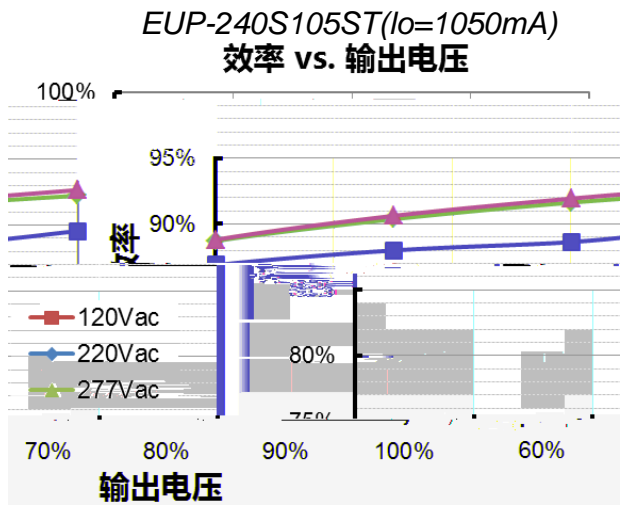
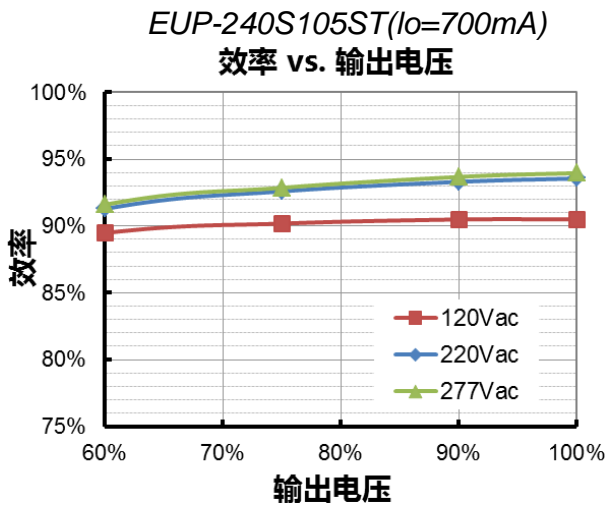
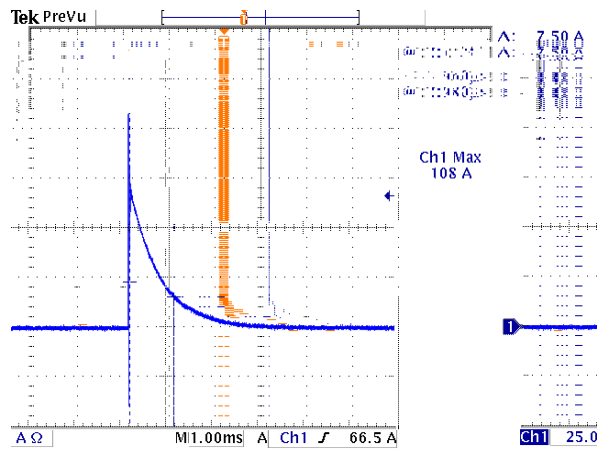
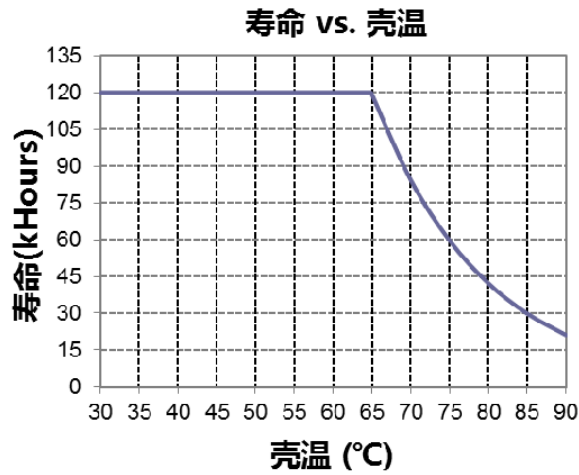

EUP-240S150ST (Io=1050mA)
效率 vs. 输出电压

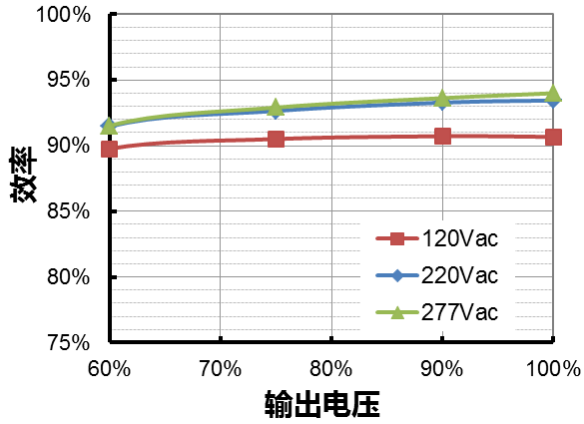

EUP-240S150ST (Io=1500mA)
效率 vs. 输出电压

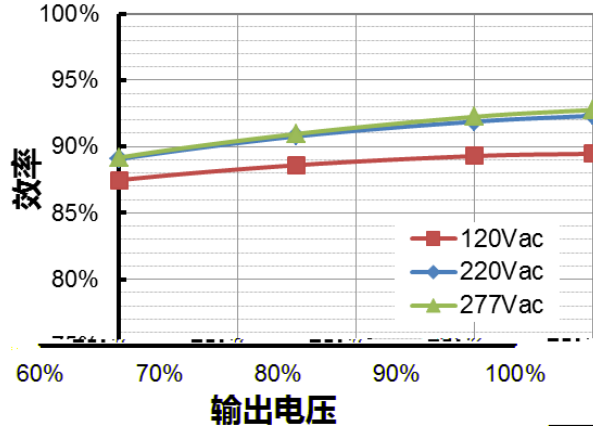

EUP-240S210ST (Io=1400mA)
效率 vs. 输出电压

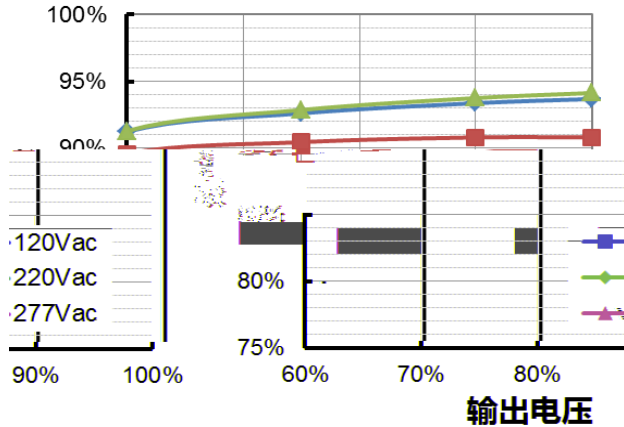

EUP-240S210ST (Io=2100mA)
效率 vs. 输出电压

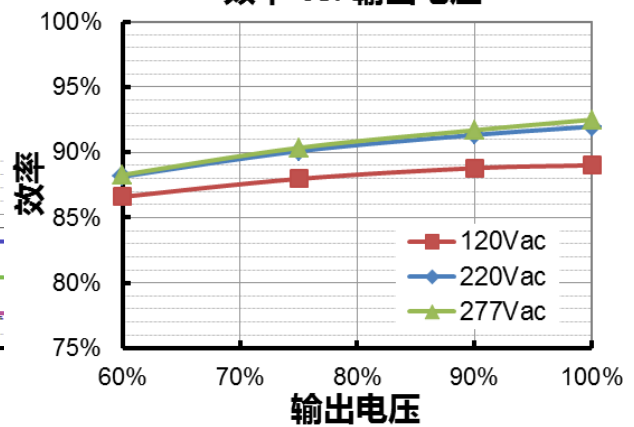

EUP-240S420ST (Io=2800mA)
效率 vs. 输出电压

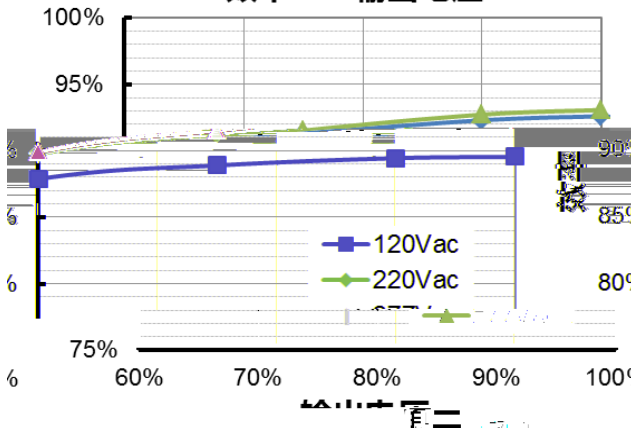

EUP-240S420ST (Io=4200mA)
效率 vs. 输出电压

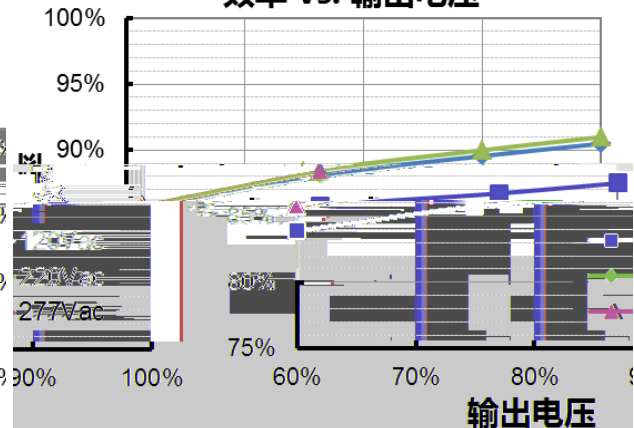

EUP-240S670ST(Io=4600mA)

效率 vs. 输出电压

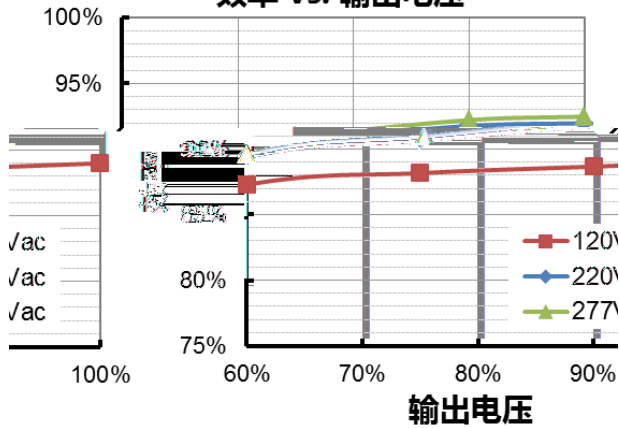

EUP-240S670ST(Io=6700mA)

效率 vs. 输出电压

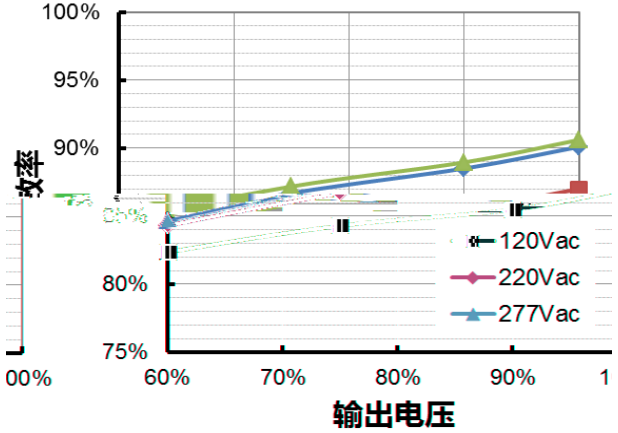

功率因数 vs. 负载

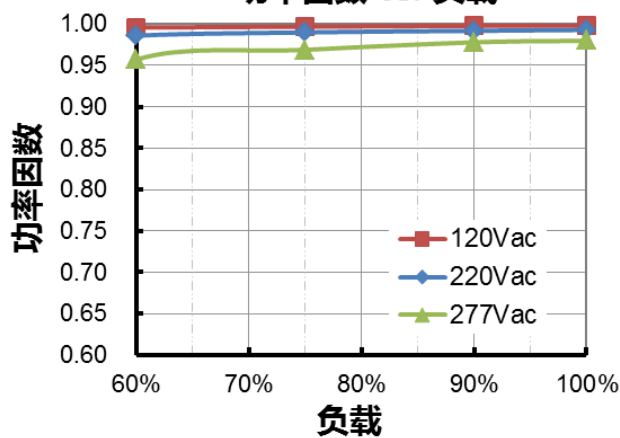

总谐波失真 vs. 负载

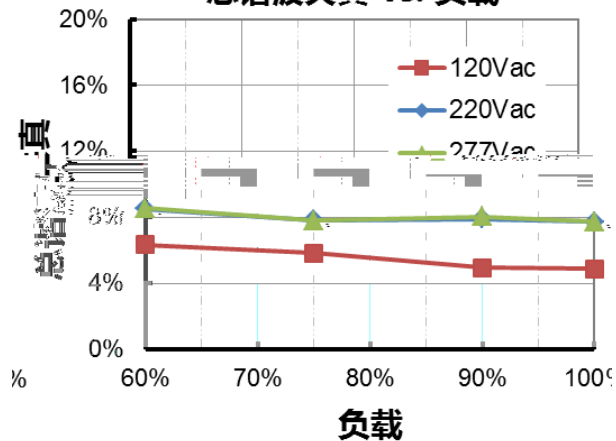

vs.

● EUP-240S105ST

	(loset)		
--	---------	--	--

● EUP-240S150ST

				(loset)			
1	2	3	4				I
ON	ON	ON	ON	1500mA	80V	160V	
ON	ON	ON	OFF	1450mA	83V	165V	
ON	ON	OFF	ON	1400mA	86V	171V	
ON	ON	OFF	OFF	1350mA	89V	178V	
ON	OFF	ON	ON	1300mA	93V	185V	
ON	OFF	ON	OFF	1250mA	96V	192V	
ON	OFF	OFF	ON	1200mA	100V	200V	
ON	OFF	OFF	OFF	1150mA	105V	209V	
OFF	ON	ON	ON	1100mA	109V	218V	
OFF	ON	ON	OFF	1050mA	115V	229V	
OFF	ON	OFF	ON	1000mA	120V	229V	
OFF	ON	OFF	OFF	950mA	127V	229V	
OFF	OFF	ON	ON	900mA	134V	229V	
OFF	OFF	ON	OFF	850mA	142V	229V	

● EUP-240S210ST

				(loset)			
1	2	3	4				I
ON	ON	ON	ON	2100mA	57V	114V	
ON	ON	ON	OFF	2000mA	60V	120V	
ON	ON	OFF	ON	1900mA	63V	126V	
ON	ON	OFF	OFF	1800mA	67V	133V	
ON	OFF	ON	ON	1700mA	71V	141V	
ON	OFF	ON	OFF	1600mA	75V	150V	
ON	OFF	OFF	ON	1500mA	80V	160V	
ON	OFF	OFF	OFF	1400mA	86V	171V	
OFF	ON	ON	ON	1300mA	92V	171V	
OFF	ON	ON	OFF	1200mA	100V	171V	
OFF	ON	OFF	ON	1100mA	109V	171V	
OFF	ON	OFF	OFF	1000mA	120V	171V	

● EUP-240S420ST

				(loset)			
1	2	3	4				I
ON	ON	ON	ON	4200mA	29V	57V	
ON	ON	ON	OFF	4000mA	30V	60V	
ON	ON	OFF	ON	3800mA	32V	63V	
ON	ON	OFF	OFF	3600mA	34V	66.5V	
ON	OFF	ON	ON	3400mA	36V	70.5V	
ON	OFF	ON	OFF	3200mA	38V	75V	
ON	OFF	OFF	ON	3000mA	40V	80V	
ON	OFF	OFF	OFF	2800mA	43V	86V	
OFF	ON	ON	ON	2600mA	46V	86V	
OFF	ON	ON	OFF	2400mA	50V	86V	
OFF	ON	OFF	ON	2200mA	55V	86V	
OFF	ON	OFF	OFF	2000mA	60V	86V	

● EUP-240S670ST

				(loset)			
1	2	3	4				I
ON	ON	ON	ON	6700mA	18V	36V	
ON	ON	ON	OFF	6400mA	19V	37.5V	
ON	ON	OFF	ON	6100mA	20V	39.5V	
ON	ON	OFF	OFF	5800mA	21V	41.5V	
ON	OFF	ON	ON	5500mA	22V	43.5V	
ON	OFF	ON	OFF	5200mA	23V	46V	
ON	OFF	OFF	ON	4900mA	25V	49V	
ON	OFF	OFF	OFF	4600mA	26V	52V	
OFF	ON	ON	ON	4300mA	28V	52V	
OFF	ON	ON	OFF	4000mA	30V	52V	
OFF	ON	OFF	ON	3700mA	33V	52V	
OFF	ON	OFF	OFF	3400mA	35V	52V	

- 1.
2. IP67

EUP-240S105ST

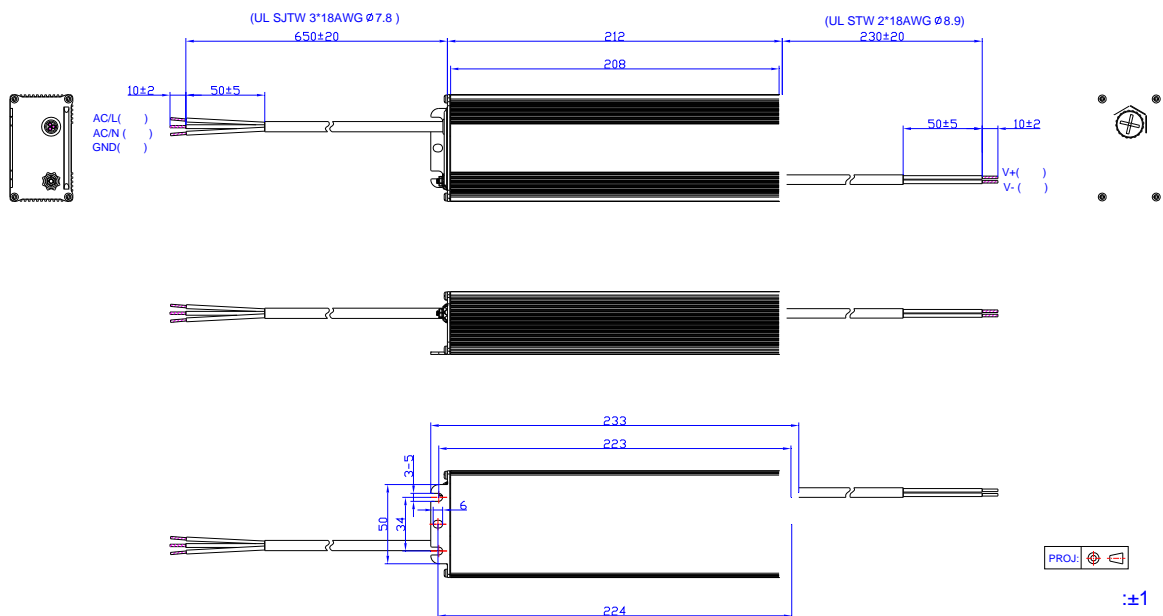

EUP-240SxxxST

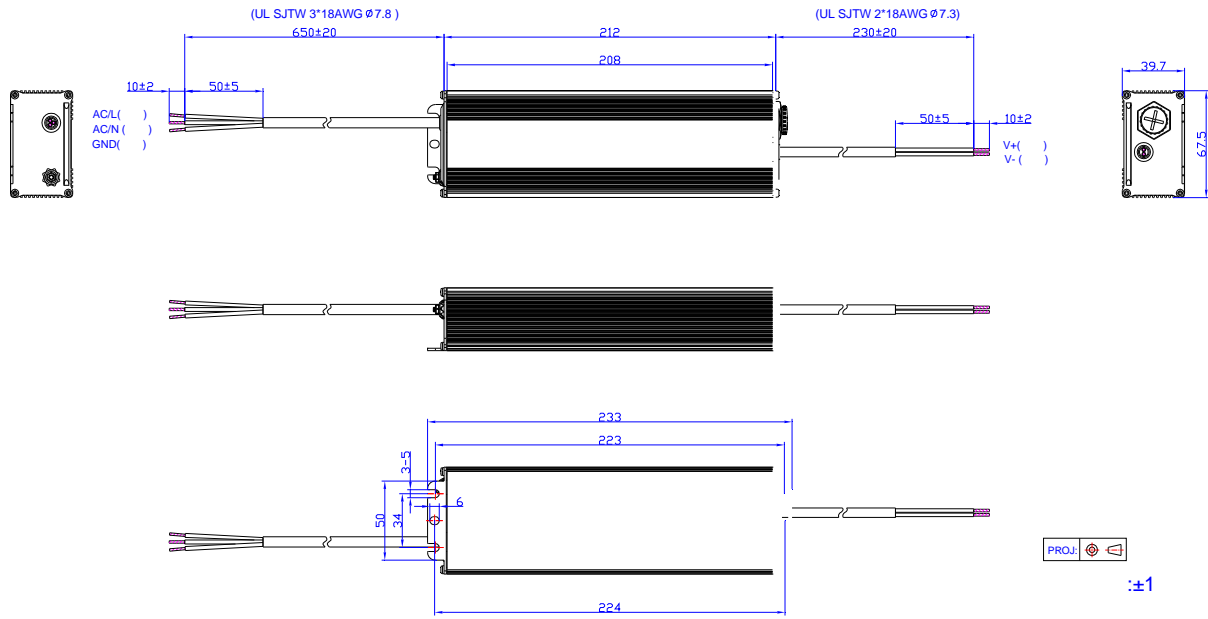

INVENTRONICS

EUP-240SxxxST

Rev. B

240W IP67

2017-11-02	A		/	/
2018-04-27	B		/	
			/	